

1

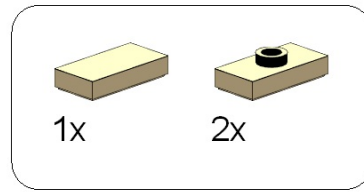

2

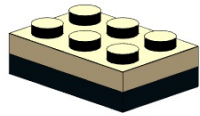
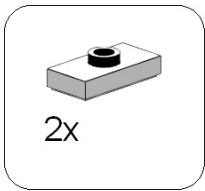
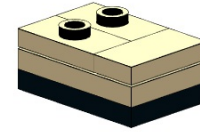

3

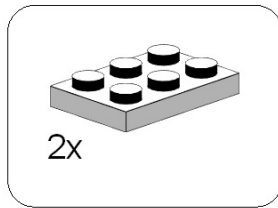
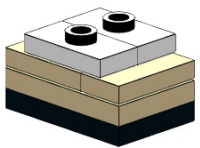

4

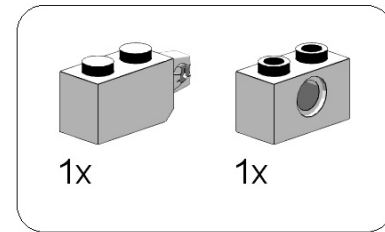
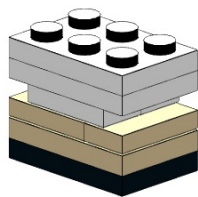

5

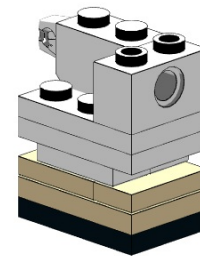

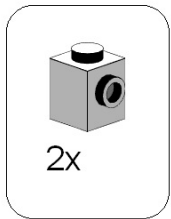

6

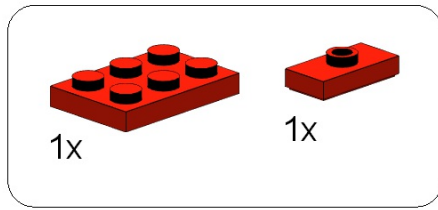
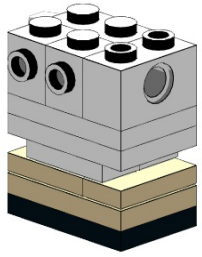

7

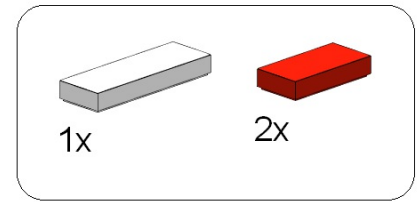
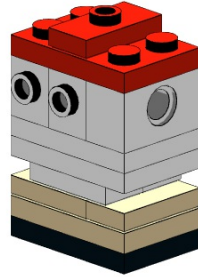

8

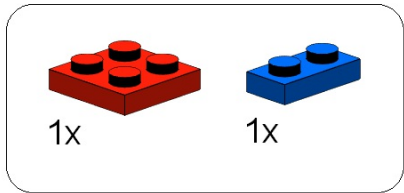
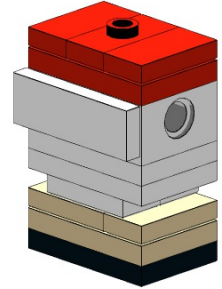

9

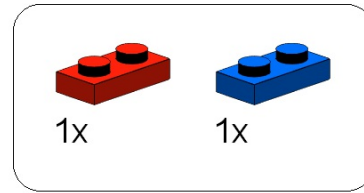
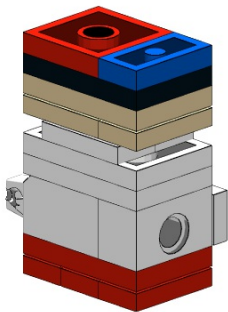
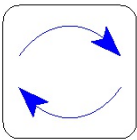

10

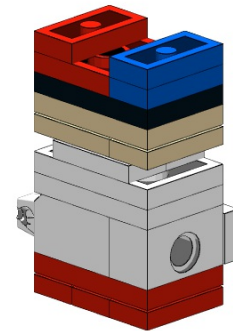



1

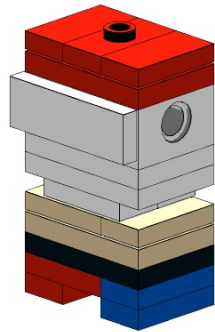

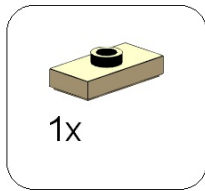
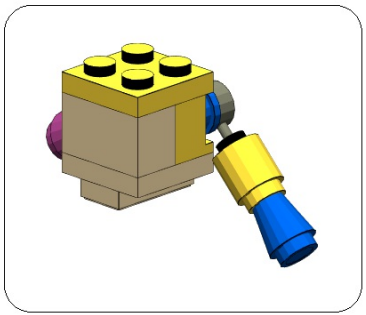

1

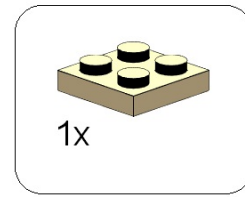
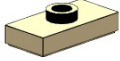

2

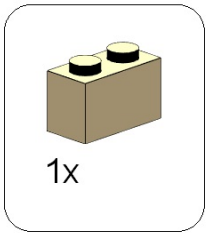
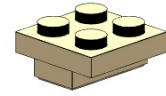

3

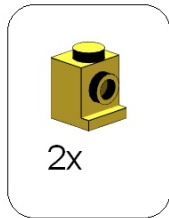
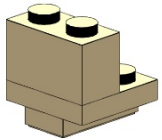

4

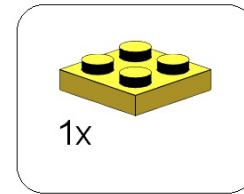
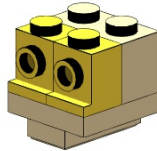
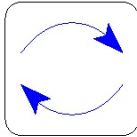

5

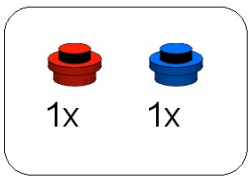
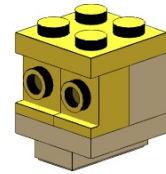

6

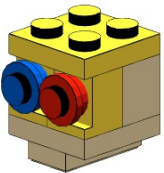

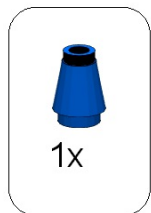
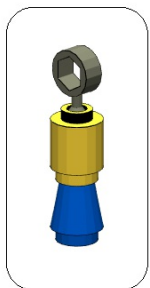

1

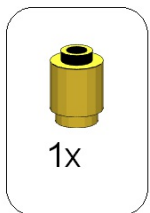

2



3





1

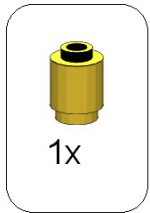

2

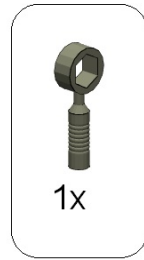

3



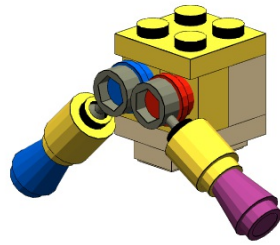
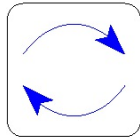





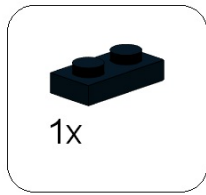
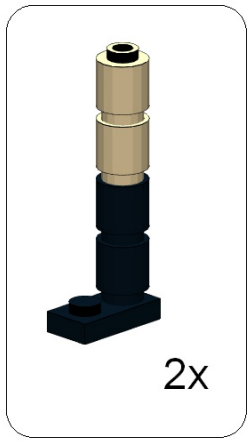

1



2

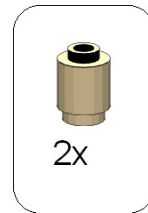
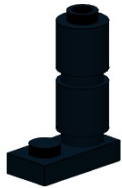

3

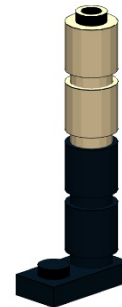



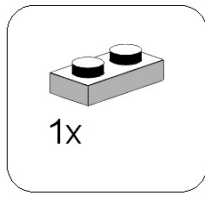
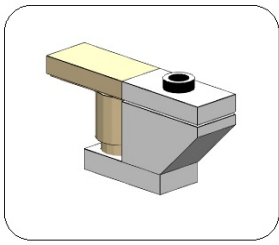

1

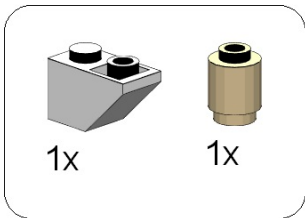
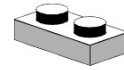

2

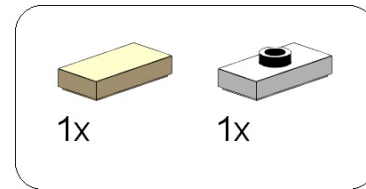
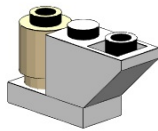

3

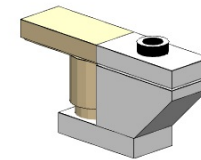

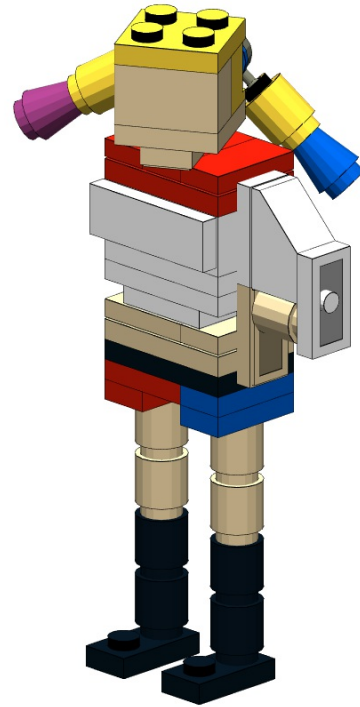

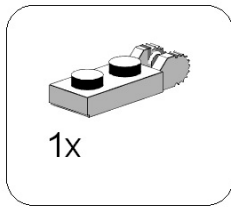
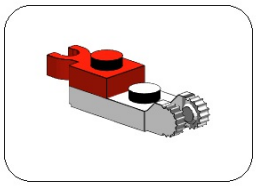

1x

1

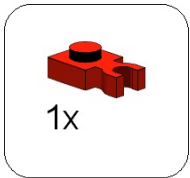
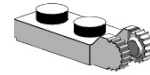

1x

2

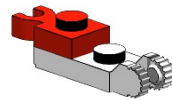

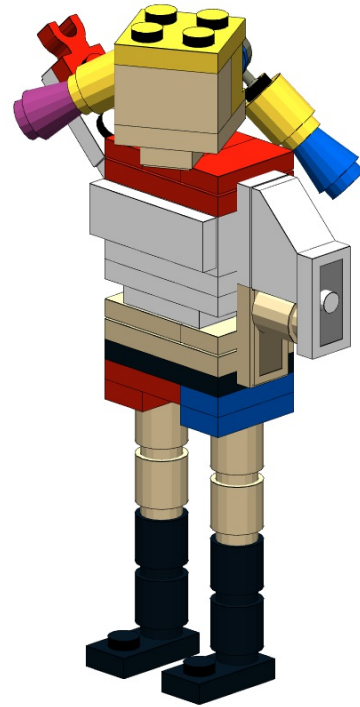

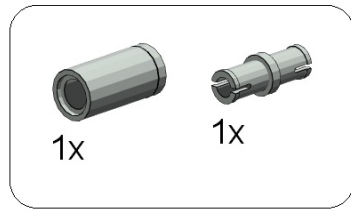
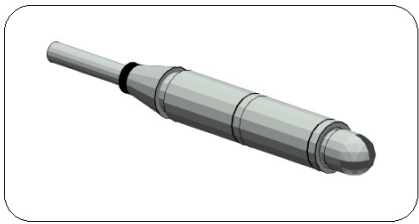

1

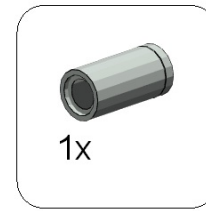

2



3

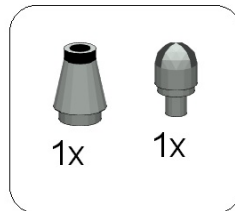

4

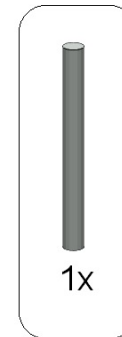

5

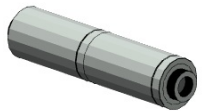



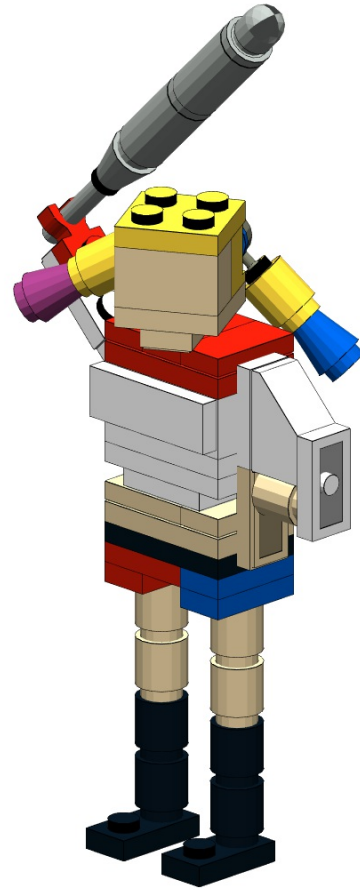



4x

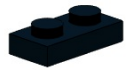

2x



1x



1x

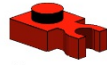

1x



1x

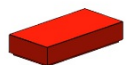

2x

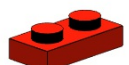

1x



1x

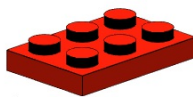

1x



1x



1x

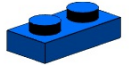

2x



2x



1x

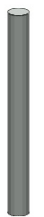

1x



1x



1x



2x



1x



2x



2x



2x

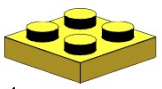

1x



5x

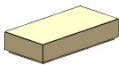

2x

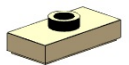

3x

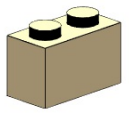

1x

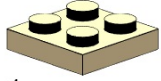

1x

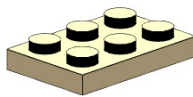

1x



2x

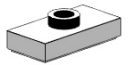

3x

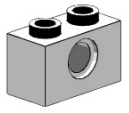

1x

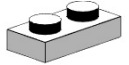

1x

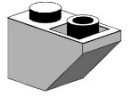

1x

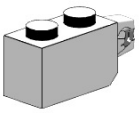

1x

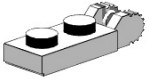

1x

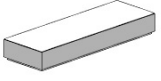

1x

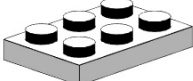

2x